

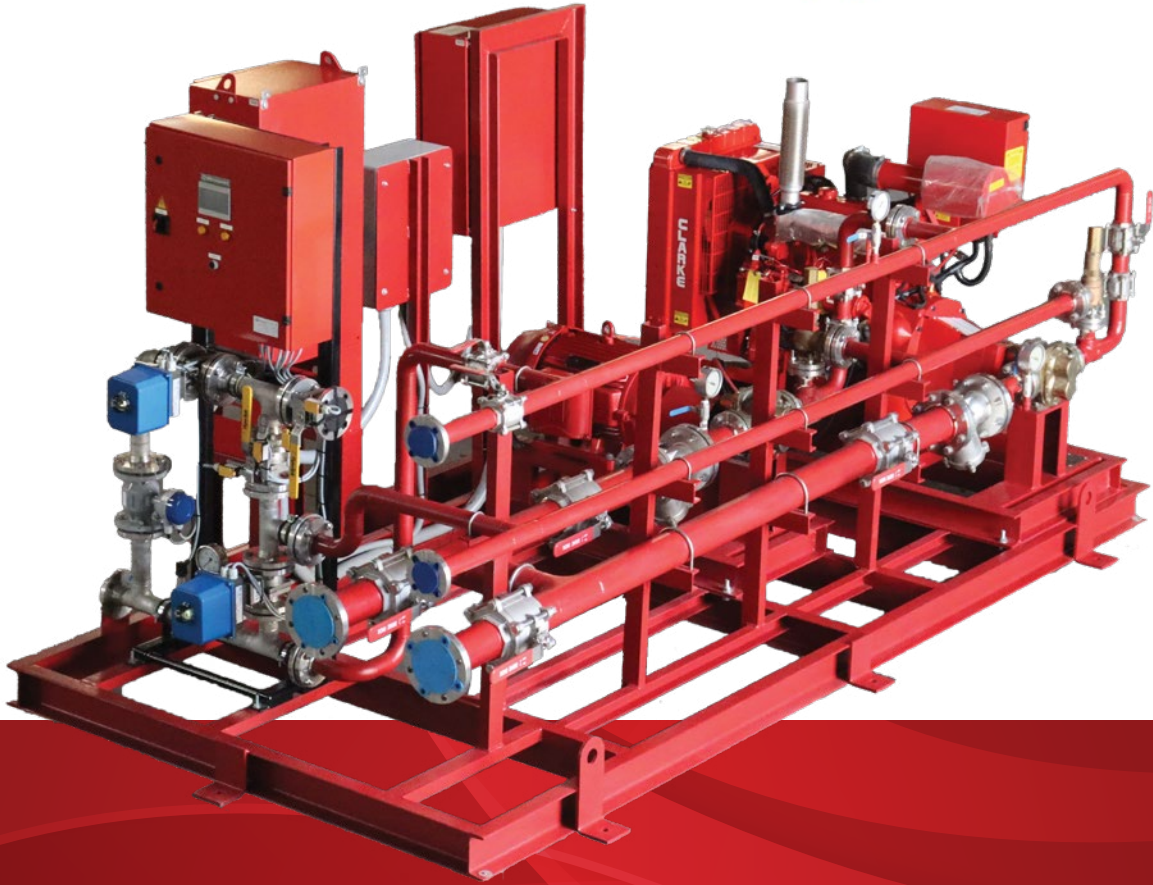

الشركة الدولية لأنظمة الأمن والسلامة
International Security & Safety Systems Co.



Foam Pumps

UL - Listed, FM Approved NFPA-20

Made in USA - Assembled in EGYPT



Introduction

With years of extensive experience in the field of foam fire protection and fire pump systems , ISS has completed it's range introducing the new EGY - FP range of foam pump skids with ranges up to 420 gpm of foam concentrate flow.

Matching the needs of high - hazard applications for the Oil & Gas, Petrochemical, Transportation, Strategic Military, Chemical, Power and most Industrial verticals, the range provides a complete solution for almost any demand.

The entire range is provided at 50 as well as 60-cycles to serve specific markets within the region that require so. ISS has been awarded UL Listing on the range for up to 420 gpm.

The entire range is UL listed, FM Approved and comes complete with the same major components of electric motor, diesel engine, fire pump controllers and all accessories that grant the entire package UL approved.

Tried and tested in some of the toughest of installation, applications and clients, the range provides a very flexible selection of flow and pressure with proven performance across the last decade in the country of Egypt.



PUMPS, FOAM CONCENTRATE



INTERNATIONAL SECURITY & SAFETY SYSTEMS CO-S A E
49 ABBASS EL AKKAD ST
NASR CITY, CAIRO EGYPT

Model	Capacity Range, gpm (lpm)	Size, in.	Speed Range, rpm	Pressure Range, psi (Mpa)	Max Working Pressure, psi (Mpa)
EGY-FP1-15	25-40 (95-152)	1 x 1	1800	100-261 (0.69-1.80)	338 (2.33)
EGY-FP1-30	24-36 (91-136)	1 x 1	1500	100-261 (0.69-1.80)	338 (2.33)
EGY-FP1-30	40-55 (152-208)	1 x 1	1800	100-261 (0.69-1.95)	338 (2.33)
EGY-FP1.5-50	40-56 (152-212)	1 1/2 x 1 1/2	1500	100-261 (0.69-1.80)	342 (2.36)
EGY-FP1.5-50	57-72 (216-273)	1 1/2 x 1 1/2	1800	100-261 (0.69-1.80)	342 (2.36)
EGY-FP1.5-75	65-90 (246-341)	1 1/2 x 1 1/2	1500	100-261 (0.69-1.81)	342 (2.36)
EGY-FP1.5-75	90-115 (341-436)	1 1/2 x 1 1/2	1800	100-261 (0.69-1.80)	342 (2.36)
EGY-FP2-100	88-119 (334-451)	2 x 2	1500	100-261 (0.69-1.80)	306 (2.11)
EGY-FP2-100	121-152 (459-576)	2 x 2	1800	100-261 (0.69-1.80)	306 (2.11)
EGY-FP2-150	107-140 (406-531)	2 x 2	1500	100-261 (0.69-1.80)	306 (2.11)
EGY-FP2-150	152-185 (387-701)	2 x 2	1800	100-261 (0.69-1.80)	306 (2.11)
EGY-FP2-175	135-180 (512-682)	3 x 3	1500	100-261 (0.69-1.80)	306 (2.11)
EGY-FP2-175	185-235 (701-891)	3 x 3	1800	100-261 (0.69-1.80)	306 (2.11)
EGY-FP3-200	158-205 (599-777)	3 x 3	1500	100-261 (0.69-1.80)	334 (2.30)
EGY-FP3-200	202-252 (766-955)	3 x 3	1800	100-261 (0.69-1.80)	334 (2.30)
EGY-FP3-225	180-240 (682-910)	3 x 3	1500	100-261 (0.69-1.80)	334 (2.30)
EGY-FP3-225	240-300 (910-1137)	3 x 3	1800	100-261 (0.69-1.80)	334 (2.30)
EGY-FP4-250	185-245 (701-925)	4 x 4	1500	100-261 (0.69-1.81)	302 (2.09)
EGY-FP4-250	250-315 (948-1194)	4 x 4	1800	100-261 (0.70-1.80)	302 (2.09)
EGY-FP4-350	280-335 (1061-1270)	4 x 4	1500	100-232 (0.70-1.60)	302 (2.09)
EGY-FP4-350	375-420 (1421-1592)	4 x 4	1800	100-232 (0.70-1.60)	302 (2.09)

Pump Specifications

- Flow rate: 91-1592 LPM (24-420 gpm).
- Rotor: Spur/Herringbone gear.
- Maximum differential pressure: 21 bar.
- Drivers: PTO, hydraulic, engine, electric or water turbine.
- Ports: Threaded or groove or flanged.
- Foam Concentrate Viscosity: up to 9320 CPS.



Models EGY-FP are available in packaged systems designed for common applications or customized to include a variety of specified drivers, controls, gauges, valves, piping, etc. for plug and play installations.

Our engineers are exceptionally knowledgeable of foam applications and are eager to help you solve your foam pumping issues.

Balanced pressure pump proportioning systems are designed to accurately control the flow of a foam liquid concentrate into a water stream over a wide range of flow rates and pressures.

These pump proportioning systems operate by matching the required foam concentrate pump output to the proportioner maximum flow demand.

Because they are capable of continuously generating large volumes of foam solution, balanced pressure pump proportioning systems are typically used to protect tank farms, marine docks, chemical processing plants, offshore oil platforms, aircraft hangars, and loading racks.

A	Foam Tank Suction
B	Foam Tank Return
C1	Foam Proportioner Supply
C2	Foam Proportioner Supply (If Required)
D	Manual Foam Balancing
E	Foam Supply to Automatic Balancing Valve
F	Foam Discharge from Automatic Balancing Valve
G	Flush Inlet
H	Flush Outlet
I1	Foam Pressure Sensing (If Required)
I2	Foam Pressure Sensing (If Required)
J	Water Sensing to Automatic Balancing Valve
K	Foam Sensing to Automatic Balancing Valve
L	Water Flush Out
M	Foam Flush Out

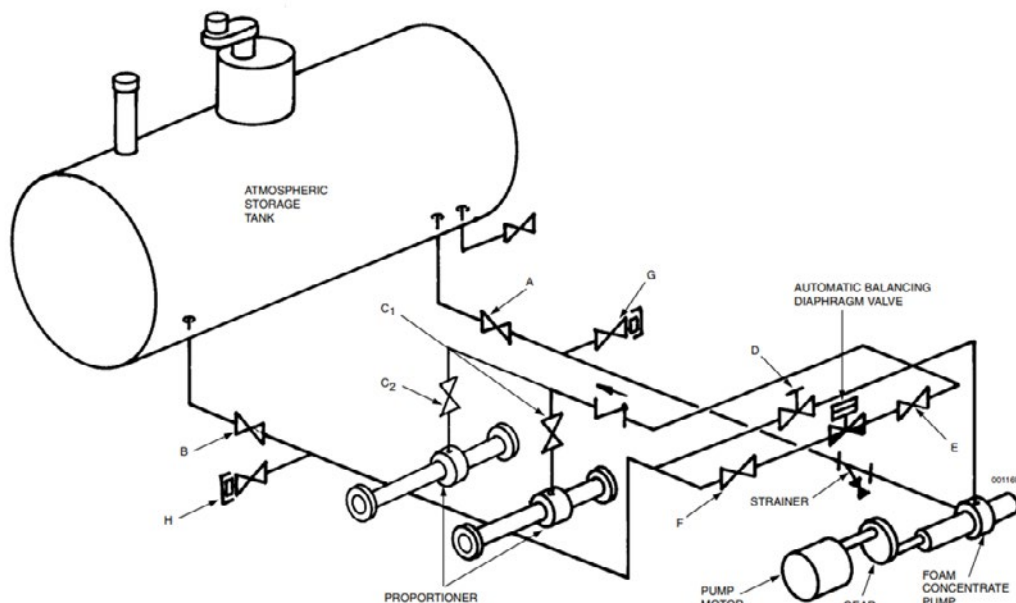

PUMP WATER HP VS DISCHARGE PRESSURE
ISS MODEL EGY-FP1-30
 PORT SIZE: 1" x 1" (NPT Connection)

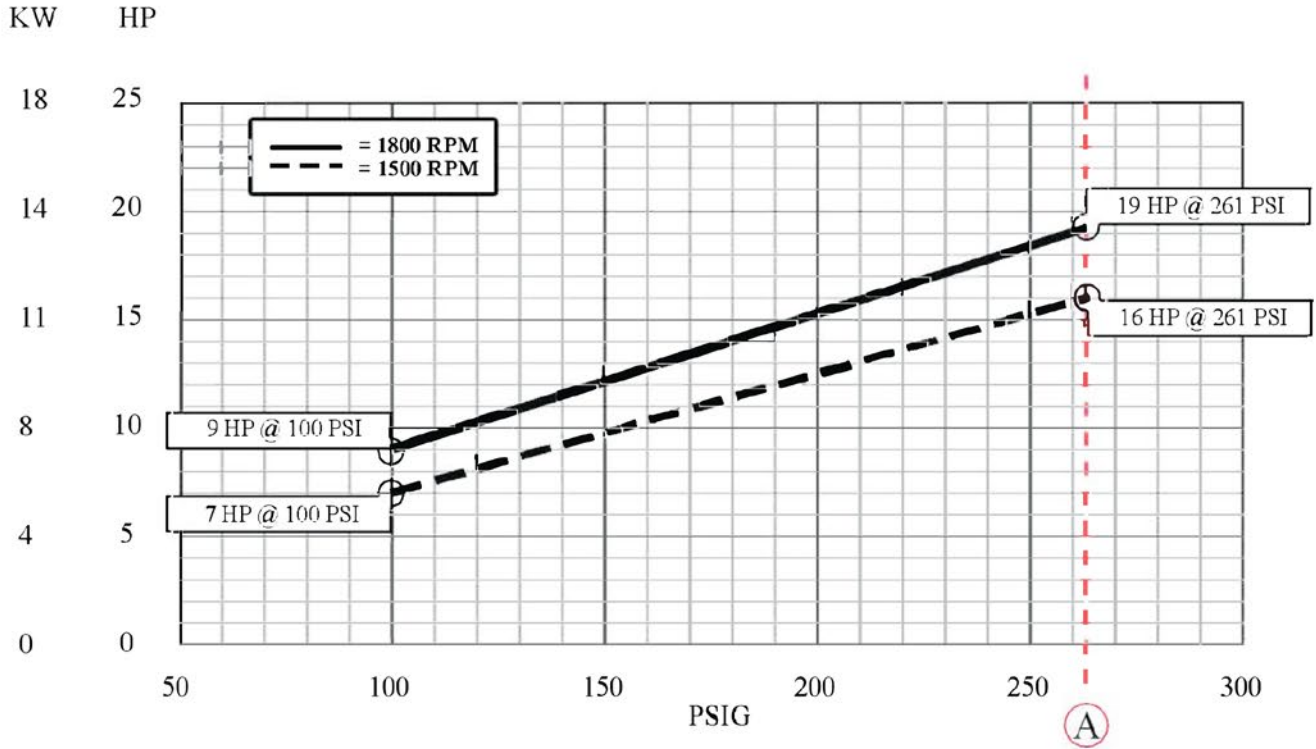

PUMP WATER FLOW RATE VS DISCHARGE PRESSURE

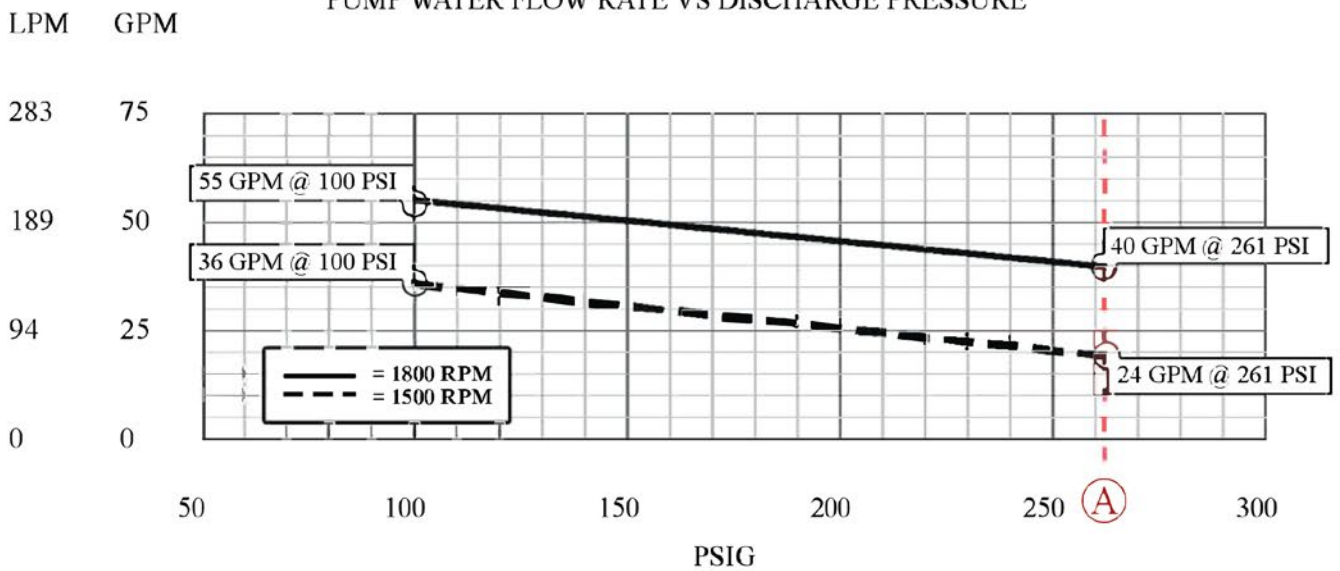

Ⓐ UL LISTED / FM APPROVED @ 18 BAR OR 261 PSIG

PUMP WATER HP VS DISCHARGE PRESSURE

ISS MODEL EGY-FP4 - 350

PORT SIZE: 4" x 4" (Groove or Flange)

PORT SIZE: 4" x 4" (Groove or Flange)

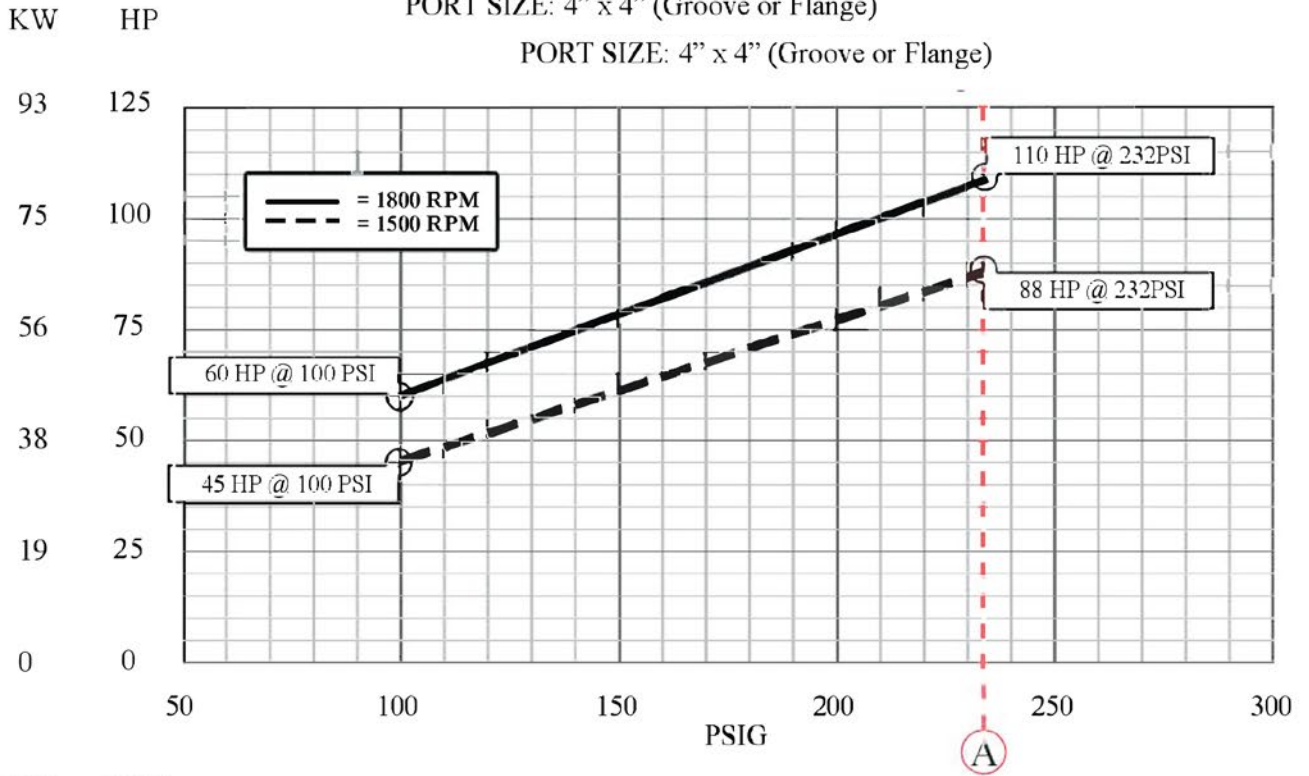

PUMP WATER FLOW RATE VS DISCHARGE PRESSURE

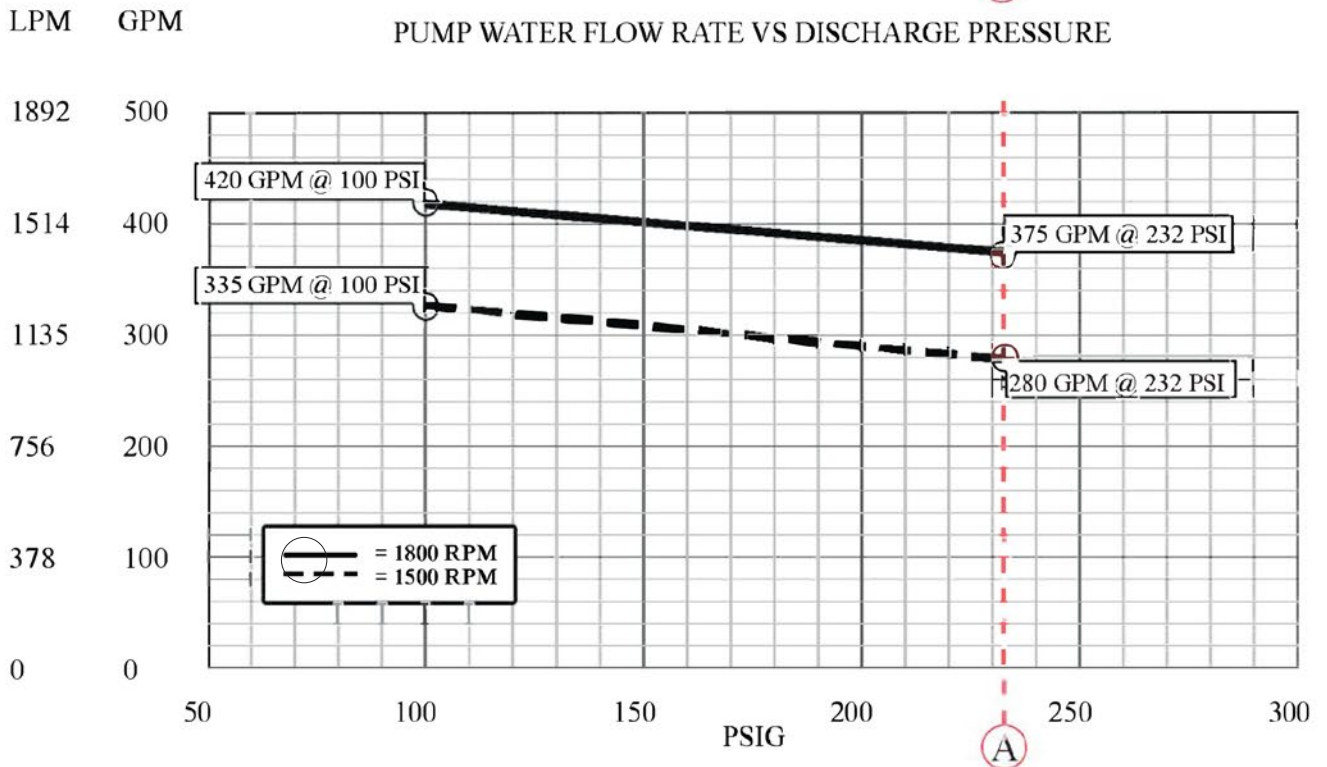

(A) UL LISTED / FM APPROVED @ 16 BAR OR 232 PSIG

Pump Drivers & Accessories

Electric Motors



Diesel Engines



Enriching Lives



Fire Pump Controllers



Jockey Pumps



Accessories



Foam Pump Skid Projects



King Abdulaziz Airport - Saudi Arabia



Pipe Petroleum Co. "PPC" - Badr



Cairo Oil Refining Co. "CORC"
- Mostorod



Suez Oil Processing Co. "SOPC" - Suez



General Petroleum Co. "GPC" - East & West Desert

You can find our Products there

Saudi Arabia
UAE
Qatar
Kenya
Sudan

Djibouti
Libya
Tunisia
Morocco
Greece

Romania
Indonesia

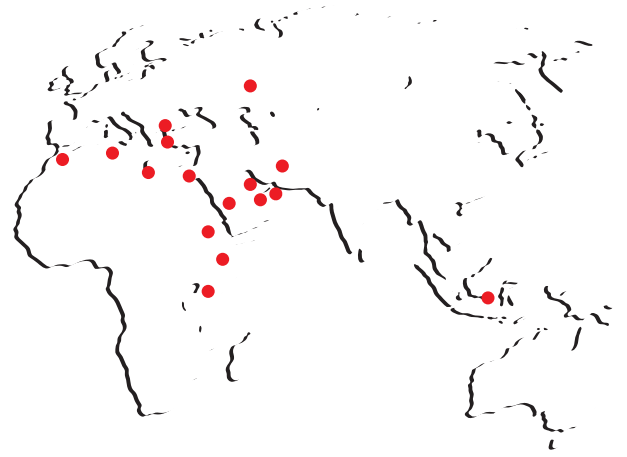

Other Products



UL-Listed Foam Bladder Tanks



UL-Listed Fire Fighting Foams



UL/FM Fire Fighting Range (250-5000)gpm



UL/FM Foam Pump Skids



HEAD OFFICE :

49 Abbas El Akkad st. - Nasr City - Cairo - Egypt

Tel : +202 (24017430 - 22602808)

Fax : +202 (22627317)

FACTORY :

Al Obour Industrial Area Block 13040 - Zone A

E-mail : info@isssystems.com



www.isssystems.com